

7

service
manual



marantz.

model twenty four

Stereo Tuner Console

TABLE OF CONTENTS

	PAGE
Introduction	1
Service Notes	1
AM Tuner	1
FM Tuner	2
FM and AM Tuner Alignment	4
Phono Amplifier	7
Tone Amplifier	7
Main Output Amplifier	7
Suggestion for Trouble Shooting of Audio Section	8
Protector Relay Circuit	8
Regulated Power Supply	9
Center Tuning Meter	9
Test Equipment for Servicing	10
Parts List	20

LIST OF ILLUSTRATIONS

FIGURE		PAGE
1	Main Chassis Component Locations Top View	11
2	Main Chassis Component Locations Bottom View	11
3	Rear Terminal Component Locations	12
4	Dial Stringing Diagram	12
5	FM Front End Assembly P100 Component Locations	13
6	AM Front End Assembly P200 Component Locations	13
7	PHONO Amplifier Assembly P300 Component Locations	14
8	Tone and Pre Amplifier Assembly P400 Component Locations	14
9	AM-FM IF and FM-MPX Demodulator Assembly P500 Component Locations	15
10	Main Amplifier Assembly P600 Component Locations	16
11	DC Amplifier and FM Audio Amplifier Assembly P700 Component Locations	17
12	Loudness, Low Filter, Hi Filter and Monitor Switch Assembly P900 Component Locations	17
13	Mono in L, R, Switches Unit Assembly P920	18
14	Tone Control Unit Assembly P940 Component Locations	18
15	Speaker Protector Circuit Assembly P980 Component Locations	18
16	Schematic Diagram	19

marantz

SERVICE BULLETIN

model number 24	bulletin number 70-7/24-1	date 2-20-70
for serial numbers	to	
subject HUM WITH THE MODEL 24		

On a few Model 24 Tuner/Preamps, when used with the Model 16, we have noted a hum that occurs as a result of an internal ground loop. This problem can be eliminated by the installation of a ground strap between terminal J 610 on the preamp board (P 600) and chassis ground.

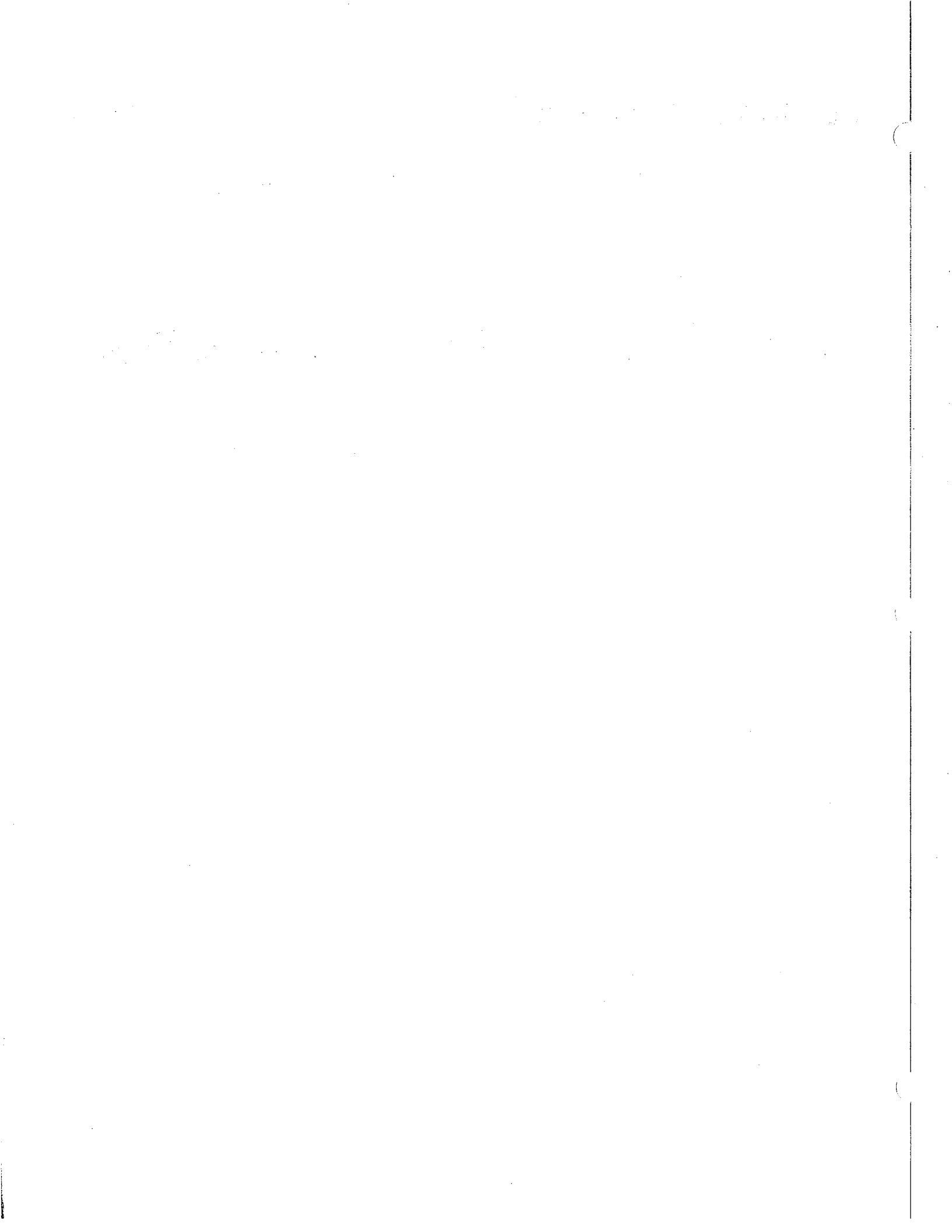

INTRODUCTION

This service manual was prepared for use by Authorized Warranty Stations and contains service data for the Marantz Model 24 Stereophonic Tuner/Console.

Servicing information and voltage data included in this manual are intended for use by knowledgeable and experienced technicians only. All instructions should be read carefully. No attempt should be made to proceed without a good understanding of the operation of the set. A brief functional description and associated block diagram, furnished in the operating Instruction Manual for the Model 24 Tuner/Console, provide functional data about the set as an aid in this understanding.

The parts list furnishes information by which replacement parts may be ordered from the Marantz Company. A description is included for parts which can usually be obtained through local suppliers.

1. SERVICE NOTES

As can be seen from the circuit diagram, the chassis of the Model 24 consists of the following units. Each unit mounted on a printed circuit board is described within the square enclosed by a bold dotted line on the circuit diagram.

1. FM Front End mounted on PC board, P100
2. AM Front End mounted on PC board, P200
3. AM IF Amplifier, FM IF Amplifier,
FM MPX Stereo Demodulator, and
FM Sub-IF Amplifier mounted on PC board, P500
4. FM Audio Amplifier and FM Cen-
ter Tuning Meter Amplifier mounted on PC board, P700
5. Tone Amplifier mounted on PC board, P400
6. Phono Amplifier mounted on PC board, P300
7. Main Output Amplifier and Regula-
ted Power Supply mounted on PC board, P600
8. High and Low Filters Unit and
Loudness Control Unit mounted on PC board, P900
9. Tone Control Unit mounted on PC board, P940
10. Monoral Switch Network mounted on PC board, P920
11. Protector Relay Driving Unit mounted on PC board, P980

2. AM TUNER

2.1 Circuit Description

The AM tuner consists of two units, a front end unit mounted on PC board P200 and an IF amplifier unit mounted on a part of PC board P500.

The front end consists of an RF amplifier and a converter. AM signals induced in a ferrite bar antenna are applied to the base of RF amplifier transistor H201 through coupling capacitor C201 and amplified to the level high enough to overcome the converter noise. The tuning

circuits placed in the input and the output circuits of the RF amplifier provide very high image ratio and sufficient spurious rejection. Thus amplified and selected signal is applied to the base of converter transistor H202 through coupling capacitor C206. The converter forms a collector-emitter self-oscillation circuit and the local oscillation signal appears at the emitter of H202. Both the signals are then mixed at the base-emitter junction and converted into 455KHz intermediate frequency. The IF signal obtained from the collector of H202 is applied to the first IF transformer L203.

Diode H203, reverse-biased by resistors R208 and R209, eliminates signal overload distortion without sacrificing any receiving sensitivity.

The IF signal output is led to the IF amplifier consisting of two stages (H510 and H511) through wiring pins J206 and J504, and amplified to high level. The amplified IF output is applied to diode H520 to detect audio signal. Then the detected audio signal is led to output pin J515 through filtering network. The DC component of the detected IF signal is used for AGC control which affects the emitter current of H510 and RF amplifier transistor H201. A part of IF signal output is also applied to diode H521 through capacitor C562 and rectified into DC current for energizing signal strength meter M001.

2.2 Suggestions for Trouble Shooting of AM Tuner

Symptom: No AM Reception

First try to tune in to stations by rotating the flywheel tuning knob slowly and observe the AM signal strength meter whether it deflects or not. If the signal strength meter gives a deflection at several frequencies received, no failure exists in the stages at least preceding IF transformer L511. Next connect an oscilloscope to tuner output pin J515 and check audio signal. If the signal strength meter does not deflect, check the local oscillator circuit. Normal oscillation voltage at the hot end of the oscillator capacitor is 2 to 3 volts, varying with the tuning capacitor position. When measuring oscillation voltage use an RF VTVM, no circuit tester gives correct indication. If the local oscillation voltage is normal, check all voltage distributions in the tuner circuit by using a circuit tester and compare the measured values with those written in the schematic diagram.

3. FM TUNER

3.1 Circuit Description

The FM tuner section consists of three printed circuit boards, FM front end, IF amplifier/MPX stereo demodulator, and DC meter amplifier/FM audio amplifier.

FM signals induced by an FM antenna are led to FM antenna coil L101 through an attenuator switch and a balun coil. These signals are then applied to an FET RF amplifier, the amplified output is applied to FET Mixer H102 through a double-tuned circuit and converted into 10.7

MHz IF signals. H103 is a local oscillator transistor. The AGC voltage, obtained by rectifying a part of the first IF transformer output, is applied to the gate of FET H101 through the network consisting of R110, R111 and R101. The converted IF signals are led to input pin J501 of the IF amplifier unit consisting of three ICs (H501, H502 and H503) and two ceramic filters having sharp cut off characteristic. The selected and fully amplified IF signal is then applied to FM discriminator transformer L507 and demodulated into audible signal.

The demodulated signal is then applied to the base of composite signal amplifier transistor H504 to obtain enough output power necessary to drive the stereo demodulating circuit packaged in IC H505. The amplified output is applied to input pin #3 of the IC. Thus R and L channel stereophonic audio signals obtained are led to the FM audio amplifier mounted on a half of PC board P700.

The FM audio amplifier consists of NPN and PNP transistors H705 and H707. The emitter of H705 is coupled to its counterpart in the other channel by separation control resistor R024. The FM audio amplifier amplifies low level FM audio signals to comparable level to those of AM and cancels out undesirable crosstalk in R and L channel signals. The output of the FM audio amplifier is led to the selector switch.

The DC current caused at point E in the FM discriminator circuit is used as a direct current source for driving FM center tuning meter M002. First the direct current is led to the base of differential amplifier transistor H701 through R514 and antenna tuning switch S002. The amplified differential output obtained across the emitters of H703 and H704 drives the center tuning meter. R704 is the trimming resistor for null adjustment of the meter.

The stereo demodulating IC is equipped with an audio muting circuit and an automatic stereo-monophonic switching circuit. Activating signals required for these circuits are obtained from the FM sub-IF amplifier consisting of two transistors H506 and H507. The amplifier obtains its input signal from the second FM IF amplifier stage through small coupling capacitor C511 and amplifies it. The amplified output is then applied to diode H517 and H518 and rectified into direct current. A part of the DC current is supplied to signal strength meter M001 through resistor R539 and rotary switch S001-3R. The other part is applied to the DC amplifier consisting of H508 and H509, and its output is then fed to the muting control pin of IC H505 through muting switch S003-2 and resistor R518. R004 is a variable resistor for muting level control. Stereo-monophonic automatic switching signal is also obtained from the rectifier circuit and applied to pin #4 of IC H505 through resistors R565, R021, diodes H516 and H515.

The model 24 is equipped with a multipath antenna tuning system for the best FM reception. A simplified principle of the tuning is given as follows. Multipath propagation of an FM signal causes amplitude and phase distortion which deteriorates not only tonal quality but channel separation. The multipath antenna tuning system is employed for the purpose of finding out the optimum antenna direction to reduce the multi-

path distortion.

A 10.7MHz FM IF signal is applied to the sub-IF amplifier and the amplified output is then rectified by diodes H517 and H518 as explained above. The rectified output is not a precise direct current but includes many amplitude modulated components caused by multipath propagation. These amplitude modulated components are separated from DC component by C552 and rectified into DC by diode H519 and led to the antenna tuning (FM center tuning) meter amplifier through antenna tuning switch S002. The greater the deflection of the antenna tuning meter, the greater the distortion of signal.

3.2 Suggestions for Trouble Shooting of FM Tuner

3.2.1 Symptom: No FM Reception

First turn on the power switch and try to tune in to FM stations. Rotate the flywheel tuning knob slowly and observe the signal strength meter and the FM center tuning meter. If the FM center tuning meter deflects at several frequencies, the tuner circuits preceding discriminator circuit may have no failure. When the signal strength meter deflects but no deflection is obtained in the FM center tuning meter, there must be some defects between the final FM IF amplifier H503 and the discriminator circuit. When no reading is obtained in both meters, check the local oscillator circuit by using an RF VTVM. Normal local oscillation voltage is about, 1 to 2 volts at the hot end of the tank circuit. If the oscillation voltage is normal, check all the voltage distributions and compare them with those shown in the schematic diagram. When both meters deflect but no FM station is obtained check the following points by using a high sensitivity oscilloscope; collector of composite amplifier transistor H504, multiplex stereo output pin J507 or J508 and FM audio output terminal J711 or J713.

3.2.2 Symptom: No Stereo Separation

First check the mono (L.R.) switches are in normal "out" position. Connect an FM RF signal modulated by a stereo signal to the FM antenna terminals and check the stereo beacon lamp is turned on or not. When the lamp is not turned on, connect an oscilloscope to the test point F and observe 38KHz stereo sub-carrier is correctly generated or not.

4. FM AND AM TUNER ALIGNMENT

The following alignment requires many precision measuring equipments shown in P.10. No alignment should be performed in the field unless the service man has these equipments and enough knowledge in solid state amplifier components, since all the units are factory aligned and not become misaligned by themselves.

4.1 AM Front End

- 1) Set an AM signal generator to 600KHz, 400Hz 30% modulation. Tune the receiver to the same frequency and adjust oscillator coil L202 until the dial pointer coincides with the 600KHz marking on the dial.
- 2) Set the AM signal generator to 1400KHz. Tune the receiver to the same frequency and adjust the trimming capacitor mounted on the tuning capacitor until the dial pointer coincides with the 1400KHz marking on the dial.
- 3) Repeat procedure 1 and 2 until no further adjustment is necessary between the low end and the high end.
- 4) Set the generator to 600KHz. Tune the receiver to the same frequency and adjust antenna coil L001 in a plastic case and RF coil L201 for maximum output.
- 5) Set the generator to 1400KHz. Tune the receiver to the same frequency and adjust each antenna trimming capacitor and RF trimming capacitor mounted on the tuning capacitor for maximum output.
- 6) Repeat procedure 4 and 5 until no further improvement is obtained.

Note: During tracking alignment reduce the signal generator output as necessary to avoid AGC action.

4.2 AM IF Amplifier

For aligning the AM IF amplifier, a sweep generator with marker generator combined is necessary.

- 1) Connect a sweep generator across pin J205 and common ground, connect an oscilloscope to test pin J527.
- 2) Turn each primary and secondary core of IF transformers L203, L510 and L511 for maximum and symmetrical response.

4.3 FM Front End

4.3.1 Local Oscillator Adjustment

- 1) Measuring instruments connection
Connect an FM signal generator to the FM antenna terminals. Connect a VTVM or an oscilloscope to the output jack.
- 2) Set the FM signal generator to 90MHz, 400Hz 100% modulation. Tune the receiver to the same frequency and adjust oscillator coil L104 until the dial pointer coincides with the 90MHz marking on the dial.
- 3) Set the FM signal generator to 106MHz. Tune the receiver to the same frequency and adjust trimming capacitor C119 until the dial pointer coincides with the 106MHz marking on the dial.

- 4) Repeat procedure 2 and 3 until no further adjustment is necessary between the low end and the high end.

4.3.2 FM Tracking Alignment

- 1) Set an FM signal generator to provide about 5uV at 90MHz. Tune the receiver to the same frequency and turn each core of L101, L102 and L103 for maximum output.
- 2) Set the FM signal generator to 106MHz. Tune the receiver to the same frequency and adjust trimming capacitors C104, C110 and C112 for maximum output.
- 3) Repeat procedure 1 and 2 until no further improvement is obtained.

4.4 FM IF Amplifier

To align the IF amplifier, connect an FM signal generator to the FM antenna terminals and set the generator to 98MHz, 400Hz 100% modulation with its output level about 5uV. Tune the receiver to this frequency and turn each core of IF transformers, L105 and L519 for maximum output. To align the discriminator transformer L507, increase the FM signal output level to about 2KuV and connect a distortion meter to the output jack.

- 1) First, tune the receiver off station to only the interstation noise is heard, then turn the secondary core of L507 so that the pointer of center tuning meter indicates its center.
- 2) Tune the receiver to a 98MHz FM signal again with the center tuning meter in its null position, then turn the primary core of discriminator transformer L507 so that minimum distortion is obtained.

4.5 FM Stereo Demodulator

A stereo multiplex and RF FM signal generator is required to make the separation adjustment on this circuit.

Perform the following adjustments in sequence.

- 1) Set an FM signal generator to 97MHz, 2KuV output level. Tune the receiver to the same frequency, be sure the pointer of center tuning meter is at the center position, and mono (L+R) switches are in their normal "out" position.
- 2) Connect an oscilloscope probe to pin J526 and turn each core of L514, L512 and L513 for maximum stereo carrier wave on the CRT.
- 3) Turn the core of L514 again to obtain equal stereo separation in both of R and L channels.
- 4) Adjust trimming resistor R024 for maximum and equal stereo separation in both channels.

Note: In early units no trimming resistor is provided.

4.6 FM Sub-IF Amplifier Alignment

To align the sub-IF amplifier, tune the receiver to an FM signal and turn each core of L508 and L509 so that the signal strength meter reads maximum deflection.

5. PHONO AMPLIFIER

A phono signal applied to the phono 1 or phono 2 jacks, selected by a section of selector switch S001-4R is led to the phono amplifier for the RIAA equalization and pre-amplification. The phono amplifier makes use of a conventional bipolar transistor H301 and a field-effect transistor H303. The collector of H301 is direct coupled to the gate of H303 and the base bias for H301 is derived from the source circuit of H303. This configuration assures a good thermal and electrical stability. R309, R311, R330, C304 and C306 condition the feedback characteristic from the drain of H303 to the emitter of H301 for precise RIAA equalization. The RIAA equalized and amplified phono signal is led back to selector switch S001-2F and S001-2R.

6. TONE AMPLIFIER

A signal from the selector switch is led through mono (R&L) switches S920-1 and S920-2, hi blend switch S003-1, tape monitor switch S901-1, antenna tuning switch S002, balance control R005 and volume control potentiometer R006 to the input pin of the tone amplifier. The tone amplifier makes use of four Transistors H401, H403, H405 and H407 in a conventional negative feedback type configuration. The tone control unit consisting of two potentiometers R941 and R942, resistors R943 and R945, and capacitors C941 and C943 is mounted on a separate PC board P940. A bootstrap configuration is utilized with H401 to provide high input impedance. The output signal of the tone control amplifier is led to the main output amplifier through hi and low filters unit mounted on PC board P900.

7. MAIN OUTPUT AMPLIFIER

A signal from the tone amplifier is applied to the base of H601 through coupling capacitor C601. High input impedance is provided by a bootstrap configuration utilized with H601. The output signal from H601 is led to the base of driver transistor H603 providing the voltage amplification necessary to drive the output stage consisting of H605 and H607 which are operated in a complimentary-symmetry configuration. The combined operation of PNP transistor H605 and NPN transistor H607 provides single ended push pull output across loading resistor R636. This output is applied to output terminal J002 through R007 and headphone jack J007.

To maintain overall stability and linearity, negative feedback is

utilized throughout the amplifier. This feedback is also necessary to reduce distortion to be well under the specified limits. R620, C621 and R609 condition the feedback signal for application to the emitter of H601.

8. SUGGESTIONS FOR TROUBLE SHOOTING OF AUDIO SECTION

8.1 Symptom: No Output for Both Channels

Check for defective power supply circuit and protector relay circuit.

8.2 Symptom: No Output or Distorted Signal for One Channel

1) Check for shorted or open transistors H401, H403, H405, H407, H601, H603, H605 and H607 or their counterparts in the channel being concerned.

2) Check for defective headphone jack J007.

3) Check all voltage distributions and compare them with those shown in the schematic diagram.

Note: Connecting an audio signal generator to the TAPE OUT jack, setting the tape monitor switch in its normal "off" position and checking input and output of each stage will be helpful to find out a bug in the audio section. For example, if the signal at the base of H601 is all right but no signal or distorted signal is obtained at the collector of H601, there must be a bug around H601.

9. PROTECTOR RELAY CIRCUIT

9.1 Circuit Description

The protector relay circuit, mounted on PC board P980, prevents the system from developing any loud "POP" sound. The relay driving circuit makes use of two transistors H982 and H983. The circuit is designed so as to short circuit the output jacks and the tape out jacks for the first several seconds after the power switch is turned on by the time constant of capacitor C982 and resistor R984.

9.2 Suggestions for Trouble Shooting of the Protector Relay Circuit

9.2.1 Symptom: No Output Signal at All Times

Check for

- 1) Shorted capacitor C982.
- 2) Open transistors H982 and H983.
- 3) Open resistors R984 and R986.
- 4) Open relay L005.

9.2.2 Symptom: "POP" Noise Appearance

Check for

- 1) Open or low value capacitor C982.
- 2) Shorted transistors H982 and H983.
- 3) Shorted resistor R984.
- 4) Defective relay L005.

10. REGULATED POWER SUPPLY

10.1 Circuit Description

The regulated power supply unit consisting of transistor H617 and zener diode H611 mounted on a part of PC board P600 supplies its regulated DC current to each unit of the main output amplifier, the FM audio amplifier, the phono amplifier and the tone amplifier. The base of transistor H617 is well fixed at 30V by zener diode H611, and H617 regulates its output voltage at about 29V. Regulator transistor H617 works as a ripple filter in conjunction with C618. Any short-circuit of the 29V DC output line may damage transistor H617. Be extremely careful not to make a short-circuit.

10.2 Suggestions for Trouble Shooting of Regulated Power Supply

10.2.1 Symptom: No Output

Check for

- 1) Open transistor H617.
- 2) Shorted capacitors C008, C616, C617, C618, C619 and C983.
- 3) Open power transformer L004.
- 4) Open resistor R635.

10.2.2 Symptom: Excessive Output Voltage

Check for

- 1) Shorted transistor H617.
- 2) Open zener diode H611.
- 3) Shorted resistor R634.

10.2.3 Symptom: Inadequate Output Voltage, Excessive Ripple

Check for

- 1) Open or low value capacitors C008 and C619.
- 2) Defective diode H613, H614, H615 and H616.

11. CENTER TUNING METER

A differential amplifier consisting of four transistors H701, H702, H703 and H704 is used to drive center tuning meter, M002. The input current to the differential amplifier is obtained from the FM discriminator through resistor R514 and antenna tuning switch S002. The null adjustment of this meter amplifier is achieved by adjusting potentiometer R704 with the selector switch placed in the PHONO 1 or PHONO 2 position.

12. TEST EQUIPMENTS FOR SERVICING

Item	Manufacturer and Model No.	Use
AM Signal Generator		Signal Source for AM Alignment
Test Loop		Used with AM Signal Generator
FM Signal Generator	Less than 0.3% distortion	Signal Source for FM Alignment
Audio Oscillator	Less than 0.02% residual distortion is required	Sine wave source for modulating AM or FM Signal Generator, or trouble shooting
Stereo Modulator	Less than 0.3% distortion	Modulating FM Signal Generator for Separation Alignment and trouble shooting
Oscilloscope	High Sensitivity	Wave form analysis and trouble shooting
VTVM	With RF probe	Trouble shooting
Circuit Tester		Trouble shooting
Sweep Generator	For 455KHz and 10.7MHz	AM and FM IF alignment
Line Voltmeter	0 - 150V AC	Line voltage monitor
Variable Auto Transformer	0 - 140V, 10 A	Line voltage adjuster

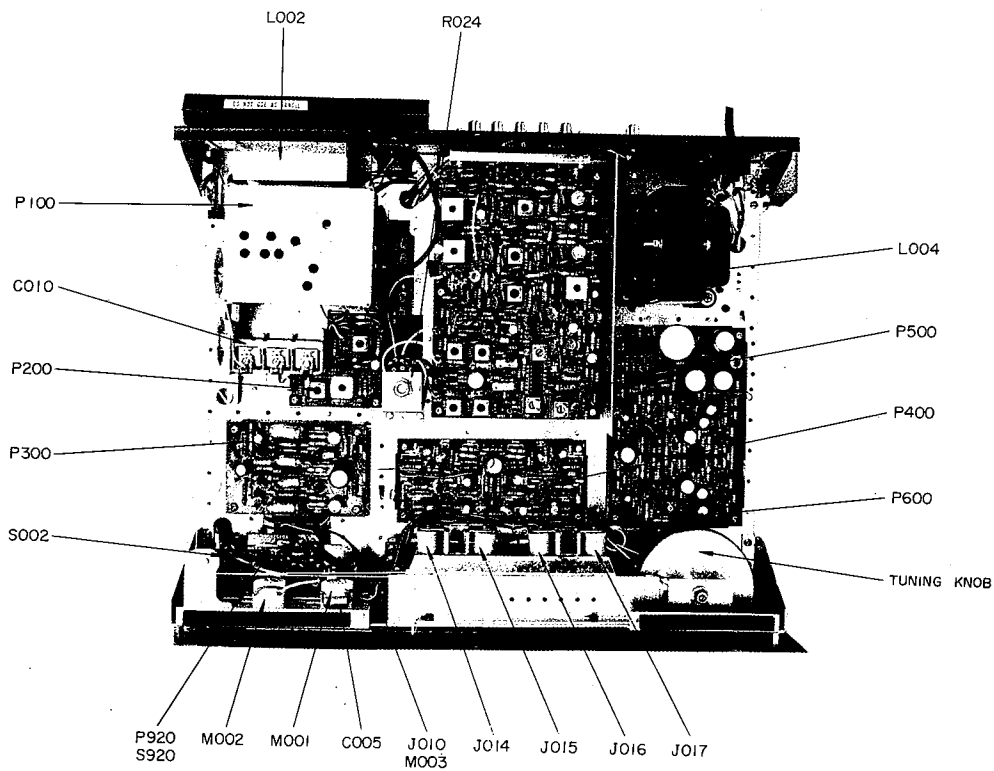

Figure 1 Main Chassis Component Locations Top View

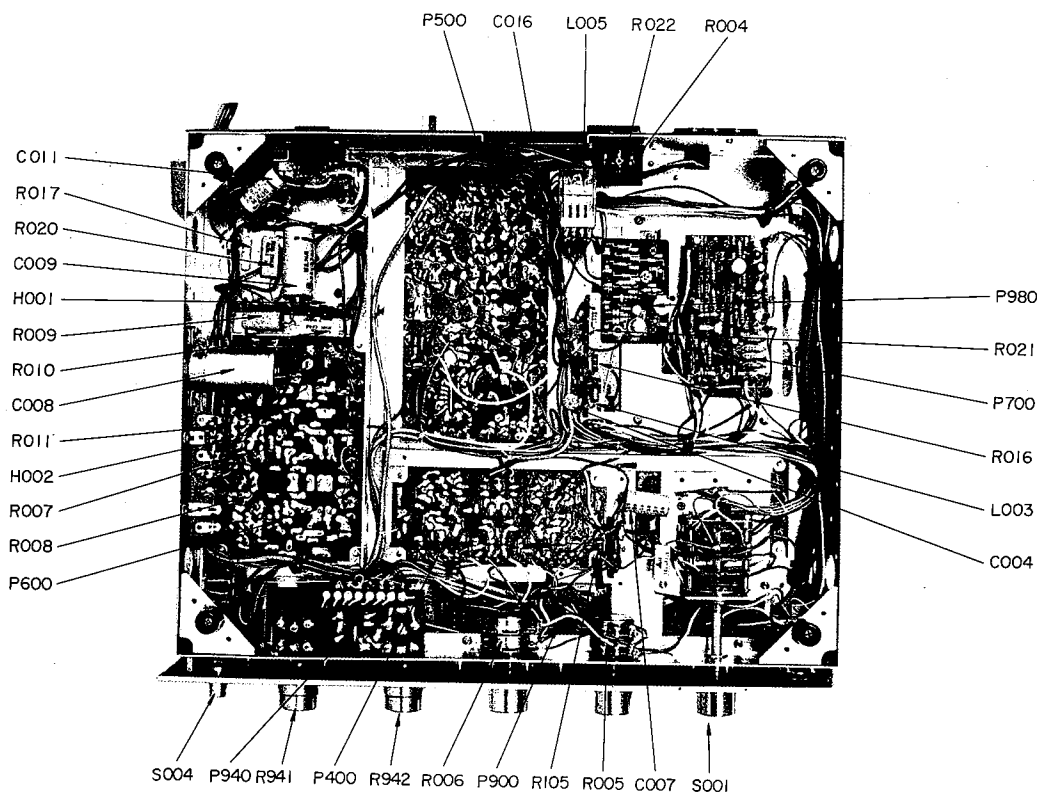

Figure 2 Main Chassis Component Locations Bottom View

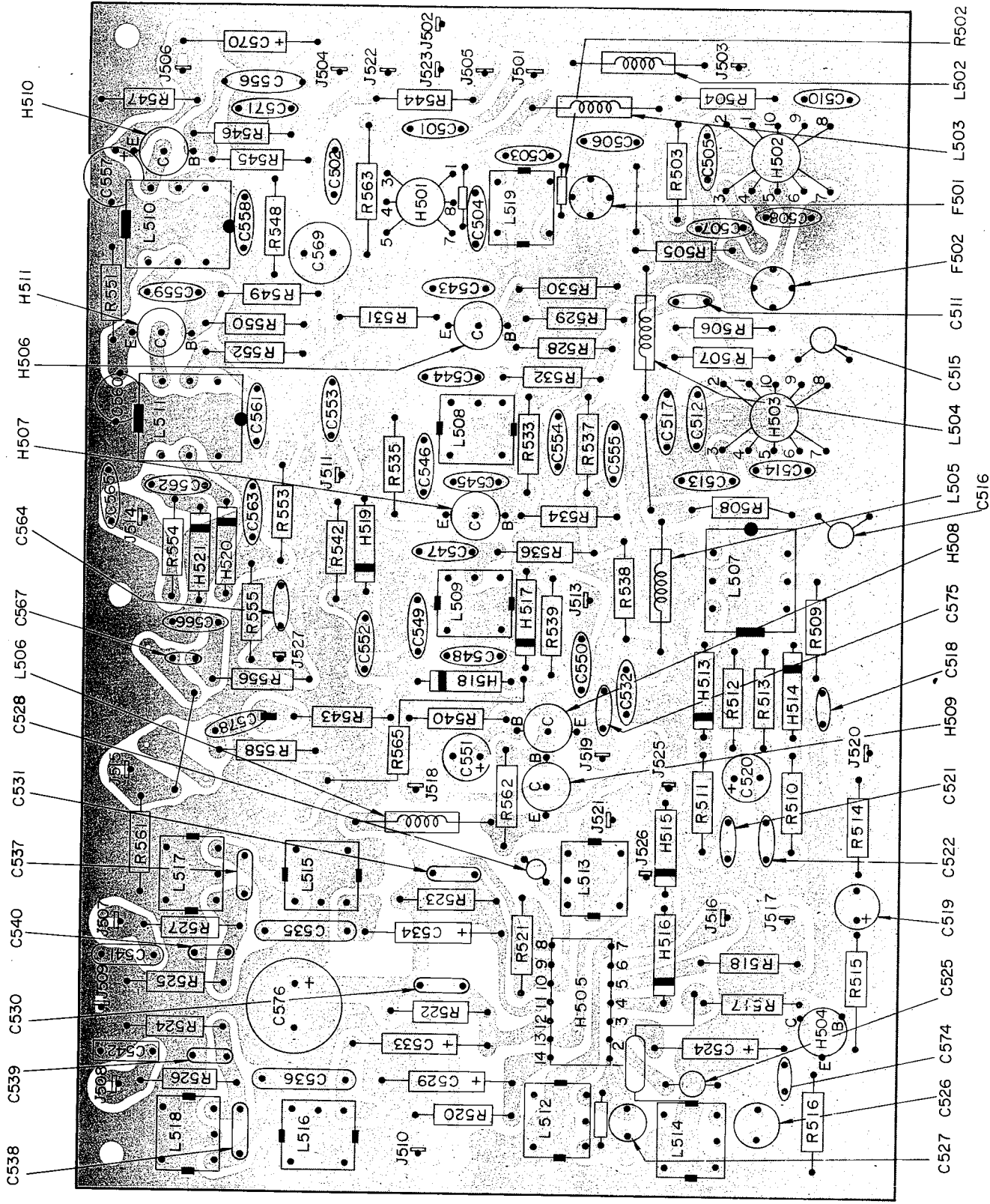

Figure 9 AM-FM IF and FM-MPX Demodulator Assembly P500 Component Locations

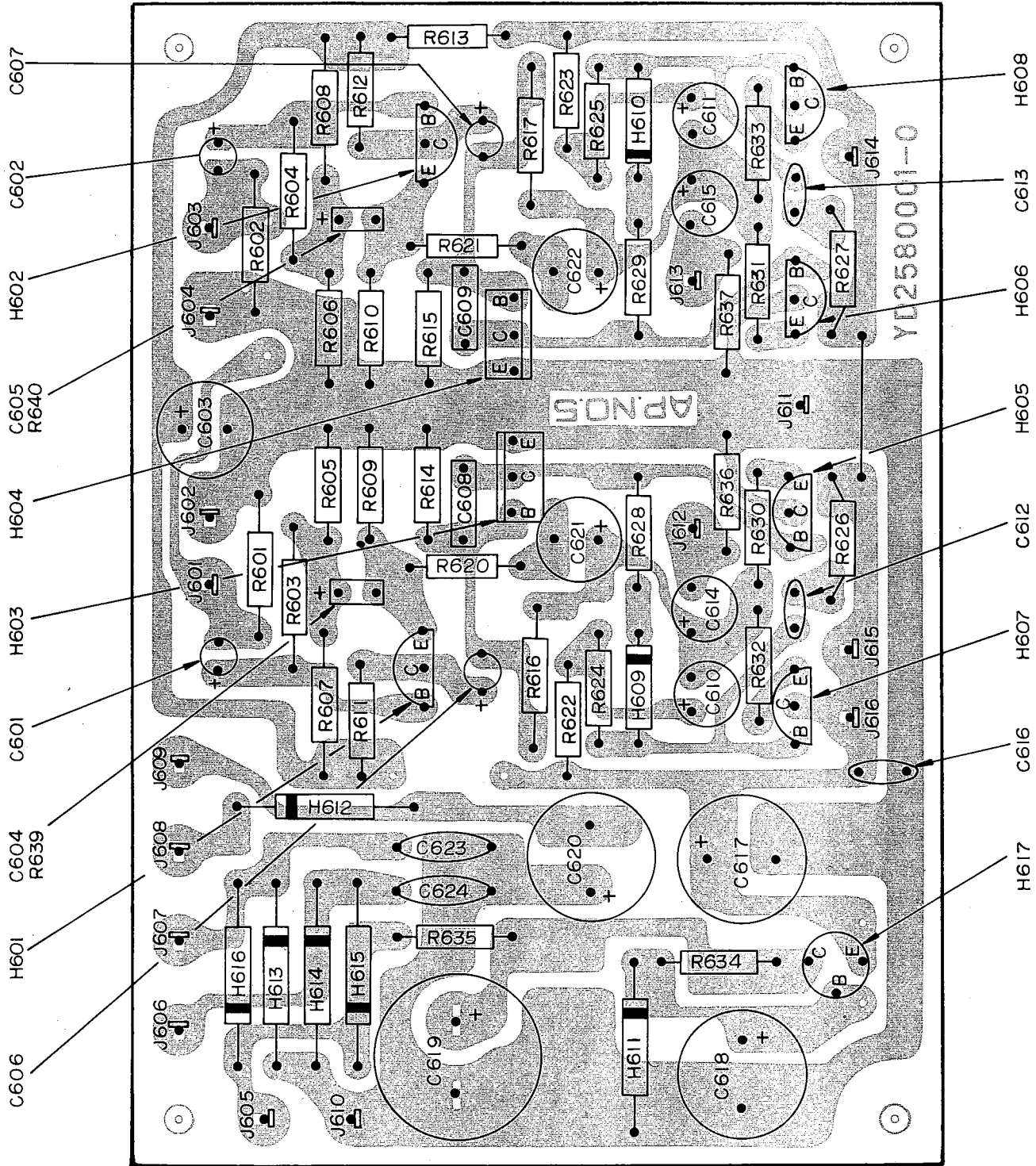

Figure 10 Main Amplifier Assembly P600 Component Locations

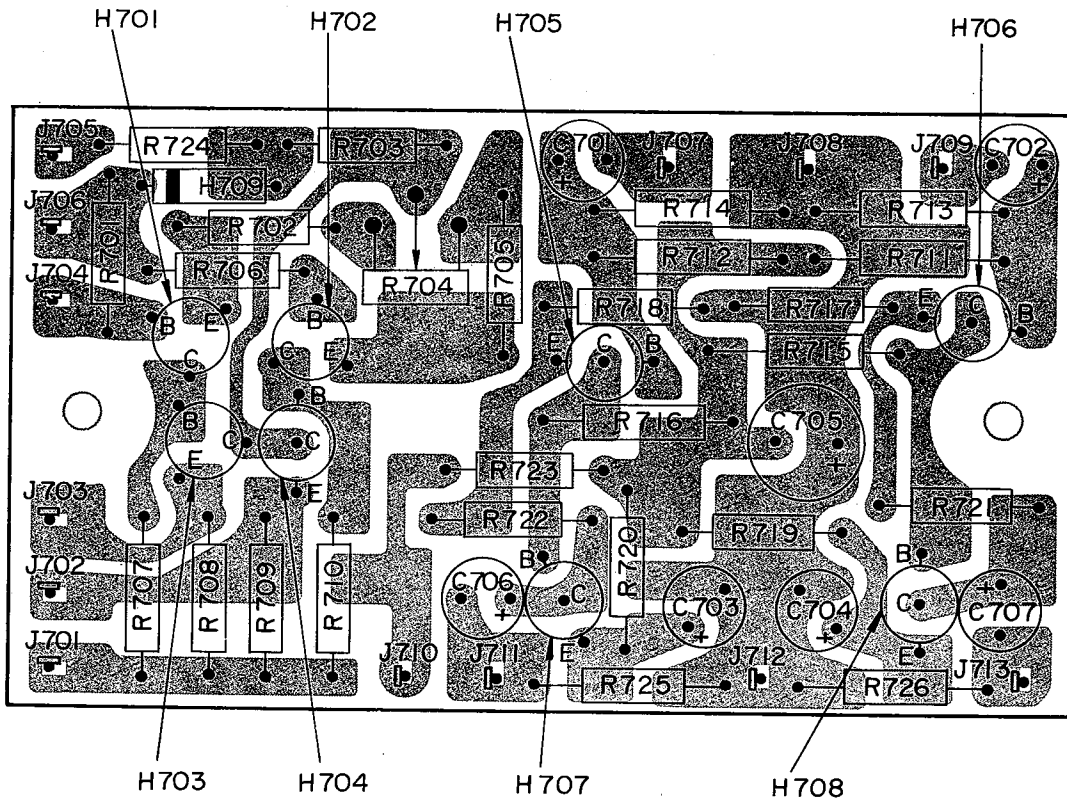

Figure 11 DC Amplifier and FM Audio Amplifier Assembly P700 Component Locations

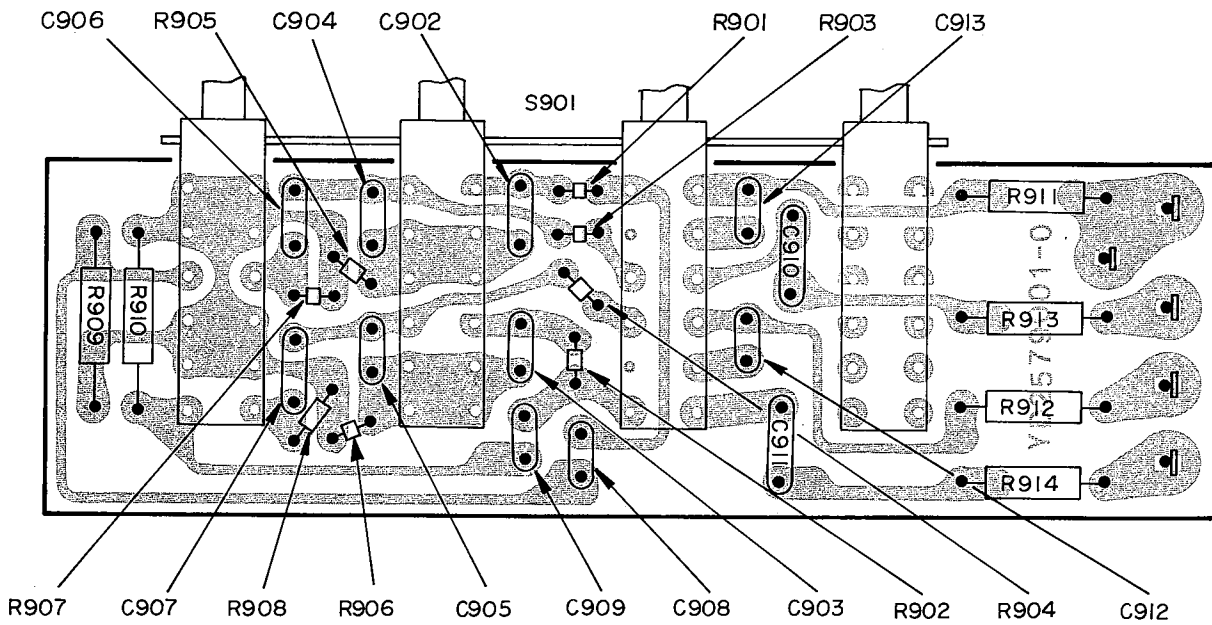

Figure 12 Loudness, Low Filter, Hi Filter and Monitor Switch Assembly P900 Component Locations

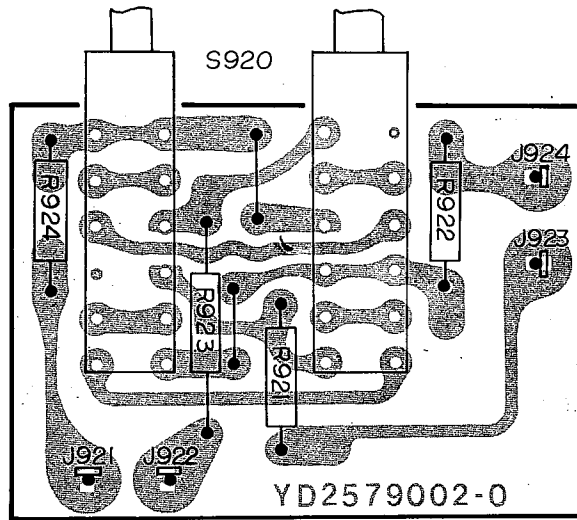

Figure 13 Mono in L, R, Switches Unit Assembly P920

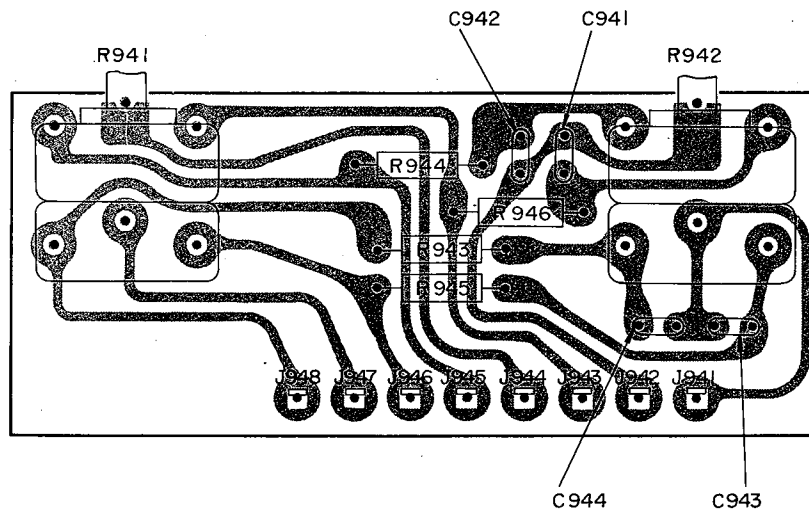

Figure 14 Tone Control Unit Assembly P940 Component Locations.

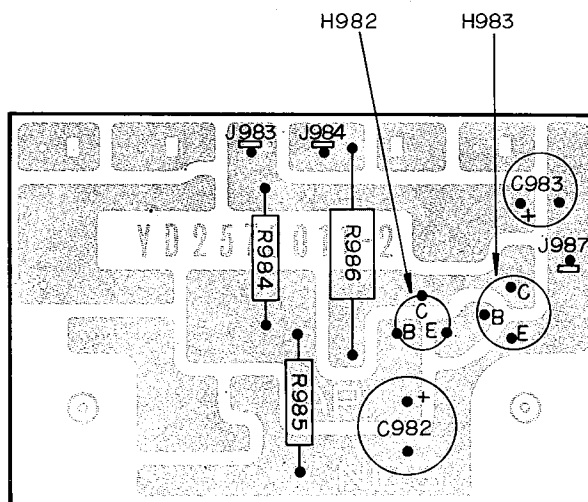

Figure 15 Speaker Protector Circuit Assembly P980 Component Locations

REF. DESIG.	MARANTZ PART NO.	DESCRIPTION
R504	RT1027114-0	270 ohm ±10% 1/4W Carbon Film
R505	RT1033114-0	330 ohm ±10% 1/4W Carbon Film
R506	RT1033114-0	330 ohm ±10% 1/4W Carbon Film
R507	RT1027114-0	270 ohm ±10% 1/4W Carbon Film
R508	RT1027214-0	2.7K ohm ±10% 1/4W Carbon Film
R509	RT1010114-0	100 ohm ±10% 1/4W Carbon Film
R510	RT1082114-0	820 ohm ±10% 1/4W Carbon Film
R511	RT1082114-0	820 ohm ±10% 1/4W Carbon Film
R512	RT1033214-0	3.3K ohm ±10% 1/4W Carbon Film
R513	RT1033214-0	3.3K ohm ±10% 1/4W Carbon Film
R514	RT1033414-0	330K ohm ±10% 1/4W Carbon Film
R515	RN1010514-0	1M ohm ±10% 1/4W Carbon Film
R516	RT1039214-0	3.9K ohm ±10% 1/4W Carbon Film
R517	RT1056214-0	5.6K ohm ±10% 1/4W Carbon Film
R518	RT1010414-0	100K ohm ±10% 1/4W Carbon Film
R520	RT1047214-0	4.7K ohm ±10% 1/4W Carbon Film
R521	RT1022214-0	2.2K ohm ±10% 1/4W Carbon Film
R522	RT1068214-0	6.8K ohm ±10% 1/4W Carbon Film
R523	RT1068214-0	6.8K ohm ±10% 1/4W Carbon Film
R524	RT1015314-0	15K ohm ±10% 1/4W Carbon Film
R525	RT1015314-0	15K ohm ±10% 1/4W Carbon Film
R526	RT1056214-0	5.6K ohm ±10% 1/4W Carbon Film
R527	RT1056214-0	5.6K ohm ±10% 1/4W Carbon Film
R528	RT1022314-0	22K ohm ±10% 1/4W Carbon Film
R529	RT1033214-0	3.3K ohm ±10% 1/4W Carbon Film
R530	RT1010314-0	10K ohm ±10% 1/4W Carbon Film
R531	RT1082114-0	820 ohm ±10% 1/4W Carbon Film
R532	RT1022114-0	220 ohm ±10% 1/4W Carbon Film
R533	RT1010314-0	10K ohm ±10% 1/4W Carbon Film
R534	RT1012314-0	12K ohm ±10% 1/4W Carbon Film
R535	RT1082114-0	820 ohm ±10% 1/4W Carbon Film
R536	RT1022114-0	220 ohm ±10% 1/4W Carbon Film
R537	RT1022014-0	22 ohm ±10% 1/4W Carbon Film
R538	RT1022014-0	22 ohm ±10% 1/4W Carbon Film
R539	RT1015314-0	15K ohm ±10% 1/4W Carbon Film
R540	RT1010414-0	100K ohm ±10% 1/4W Carbon Film
R541	RT1022414-0	220K ohm ±10% 1/4W Carbon Film
R542	RT1033414-0	330K ohm ±10% 1/4W Carbon Film
R543	RT1010414-0	100K ohm ±10% 1/4W Carbon Film
R544	RT1022214-0	2.2K ohm ±10% 1/4W Carbon Film
R545	RT1015414-0	150K ohm ±10% 1/4W Carbon Film
R546	RT1056214-0	5.6K ohm ±10% 1/4W Carbon Film
R547	RT1010214-0	1K ohm ±10% 1/4W Carbon Film
R548	RT1012214-0	1.2K ohm ±10% 1/4W Carbon Film
R549	RT1027314-0	27K ohm ±10% 1/4W Carbon Film
R550	RT1010314-0	10K ohm ±10% 1/4W Carbon Film
R551	RT1010214-0	1K ohm ±10% 1/4W Carbon Film
R552	RT1022114-0	220 ohm ±10% 1/4W Carbon Film
R553	RT1027314-0	27K ohm ±10% 1/4W Carbon Film
R554	RT1056214-0	5.6K ohm ±10% 1/4W Carbon Film
R555	RT1033214-0	3.3K ohm ±10% 1/4W Carbon Film
R556	RT1033214-0	3.3K ohm ±10% 1/4W Carbon Film
R558	RT1022414-0	220K ohm ±10% 1/4W Carbon Film

REF. DESIG.	MARANTZ PART NO.	DESCRIPTION
R560	RT1022314-0	22K ohm ±10% 1/4W Carbon Film
R561	RT1047414-0	470K ohm ±10% 1/4W Carbon Film
R562	RT1015314-0	15K ohm ±10% 1/4W Carbon Film
R563	RT1015214-0	1.5K ohm ±10% 1/4W Carbon Film
R564	RT1010114-0	100 ohm ±10% 1/4W Carbon Film
R565	RC1022312-0	22K ohm ±10% 1/2W Solid
R566	RT1010414-0	100K ohm ±10% 1/4W Carbon Film
R567	RT1082114-0	820 ohm ±10% 1/4W Carbon Film
R568	RC1010112-0	100 ohm ±10% 1/2W Solid
C501	DK1710301-0	0.01uF ±20% Ceramic
C502	DK1710301-0	0.01uF ±20% Ceramic
C503	DK1710301-0	0.01uF ±20% Ceramic
C504	DK1710301-0	0.01uF ±20% Ceramic
C505	DK1710301-0	0.01uF ±20% Ceramic
C506	DK1710301-0	0.01uF ±20% Ceramic
C507	DK1710301-0	0.01uF ±20% Ceramic
C508	DK1710301-0	0.01uF ±20% Ceramic
C510	DK1710301-0	0.01uF ±20% Ceramic
C511	DD1105001-0	5PF ±0.5PF Ceramic
C512	DK1710301-0	0.01uF ±20% Ceramic
C513	DK1710301-0	0.01uF ±20% Ceramic
C514	DK1710301-0	0.01uF ±20% Ceramic
C515	DK1710301-0	0.01uF ±20% Ceramic
C516	DK1710301-0	0.01uF ±20% Ceramic
C517	DK1710301-0	0.01uF ±20% Ceramic
C518	DD1620101-0	200PF ±10% Ceramic
C519	EA4750162-0	4.7uF 16V Elect.
C520	EA1060162-0	10uF 16V Elect.
C521	DD1620101-0	200PF ±10% Ceramic
C522	DD1620101-0	200PF ±10% Ceramic
C523	DD1650101-0	500PF ±10% Ceramic
C524	ED4750102-0	4.7uF 10V Elect.
C525	DF1747301-0	0.047uF ±20% Mylar
C526	DF5547201-0	0.0047uF ±5% Mylar
C527	DF5547201-0	0.0047uF ±5% Mylar
C528	DF5412201-0	0.0012uF ±2% Mylar
C529	ED3350163-0	3.3uF 16V Elect.
C530	DF1633201-0	0.0033uF ±10% Mylar
C531	DF1633201-0	0.0033uF ±10% Mylar
C532	DK1710301-0	0.01uF ±20% Ceramic
C533	ED4750102-0	4.7uF 10V Elect.
C534	ED4750102-0	4.7uF 10V Elect.
C535	DF6582101-0	820PF ±5% Poly
C536	DF6582101-0	820PF ±5% Poly
C537	DF1633201-0	0.0033uF ±10% Mylar
C538	DF1633201-0	0.0033uF ±10% Mylar
C539	DF1633201-0	0.0033uF ±10% Mylar
C540	DF1633201-0	0.0033uF ±10% Mylar
C541	DF1668201-0	0.0068uF ±20% Mylar
C542	DF1668201-0	0.0068uF ±20% Mylar
C543	DK1710301-0	0.01uF ±20% Ceramic
C544	DK1710301-0	0.01uF ±20% Ceramic
C545	DK1710301-0	0.01uF ±20% Ceramic
C546	DK1710301-0	0.01uF ±20% Ceramic
C547	DK1710301-0	0.01uF ±20% Ceramic
C548	DD1620101-0	200PF ±10% Ceramic

REF. MARANTZ DESIG. PART NO.	DESCRIPTION
R710	RT1022314-0 22K ohm ±10% 1/4W Carbon Film
R711	RN1047414-0 470K ohm ±10% 1/4W Carbon Film
R712	RN1047414-0 470K ohm ±10% 1/4W Carbon Film
R713	RN1015414-0 150K ohm ±10% 1/4W Carbon Film
R714	RN1015414-0 150K ohm ±10% 1/4W Carbon Film
R715	RN1022314-0 22K ohm ±10% 1/4W Carbon Film
R716	RN1022314-0 22K ohm ±10% 1/4W Carbon Film
R717	RT1056214-0 5.6K ohm ±10% 1/4W Carbon Film
R718	RT1056214-0 5.6K ohm ±10% 1/4W Carbon Film
R719	RT1010214-0 5.6K ohm ±10% 1/4W Carbon Film
R720	RT1010214-0 5.6K ohm ±10% 1/4W Carbon Film
R721	RT1015314-0 15K ohm ±10% 1/4W Carbon Film
R722	RT1015314-0 15K ohm ±10% 1/4W Carbon Film
R723	RT1039214-0 3.9K ohm ±10% 1/4W Carbon Film
R724	RT1068114-0 680 ohm ±10% 1/4W Carbon Film
R725	RT1022414-0 220K ohm ±10% 1/4W Carbon Film
R726	RT1022414-0 220K ohm ±10% 1/4W Carbon Film
C701	EN2240251-0 0.22uF ±20% 25V Elect.
C702	EV2240251-0 0.22uF ±20% 25V Elect.
C703	EA1060351-0 10uF 35V Elect.
C704	EA1060351-0 10uF 35V Elect.
C705	EA1070252-0 100uF 25V Elect.
C706	EM4740251-0 0.47uF ±20% 25V Elect.
C707	EM4740251-0 0.47uF ±20% 25V Elect.
H701	HT3037210-0 2SC372 Transistor
H702	HT3037210-0 2SC372 Transistor
H703	HT104951A-0 2SA495 R Transistor
H704	HT104951A-0 2SA495 R Transistor
H705	HT304580Z-0 Transistor
H706	HT304580Z-0 Transistor
H707	HT104941C-0 2SA494 Y Transistor
H708	HT104941C-0 2SA494 Y Transistor
H709	HD3001009-0 IS336 Diode
J701	YP1000036-0 Plug
J702	YP1000036-0 Plug
J703	YP1000036-0 Plug
J704	YP1000036-0 Plug
J705	YP1000036-0 Plug
J706	YP1000036-0 Plug
J707	YP1000036-0 Plug
J708	YP1000036-0 Plug
J709	YP1000036-0 Plug
J710	YP1000036-0 Plug
J711	YP1000036-0 Plug
J712	YP1000036-0 Plug
J713	YP1000036-0 Plug
P300	YD2577003-0 Phono Amp PC Board
R301	RN1047314-0 47K ohm ±10% 1/4W Carbon Film
R302	RN1047314-0 47K ohm ±10% 1/4W Carbon Film
R303	RT1039114-0 390 ohm ±10% 1/4W Carbon Film
R304	RT1039114-0 390 ohm ±10% 1/4W Carbon Film
R305	RN1033414-0 330K ohm ±10% 1/4W Carbon Film
R306	RN1033414-0 330K ohm ±10% 1/4W Carbon Film

REF. MARANTZ DESIG. PART NO.	DESCRIPTION
R307	GT0533112-0 330 ohm ±5% 1/2W Carbon Film
R308	GT0533112-0 330 ohm ±5% 1/2W Carbon Film
R309	GT0533412-0 330K ohm ±5% 1/2W Carbon Film
R310	GT0533412-0 330K ohm ±5% 1/2W Carbon Film
R311	GT0527312-0 27K ohm ±5% 1/2W Carbon Film
R312	GT0527312-0 27K ohm ±5% 1/2W Carbon Film
R313	RN1010414-0 100K ohm ±10% 1/4W Carbon Film
R314	RN1010414-0 100K ohm ±10% 1/4W Carbon Film
R315	RT1010314-0 10K ohm ±10% 1/4W Carbon Film
R316	HT1012314-0 12K ohm ±10% 1/4W Carbon Film
R317	HT1012314-0 12K ohm ±10% 1/4W Carbon Film
R318	RT1015214-0 1.5K ohm ±10% 1/4W Carbon Film
R319	RT1015214-0 1.5K ohm ±10% 1/4W Carbon Film
R320	RT1047114-0 470 ohm ±10% 1/4W Carbon Film
R321	RT1047114-0 470 ohm ±10% 1/4W Carbon Film
R322	RT1047014-0 47 ohm ±10% 1/4W Carbon Film
R323	RN1033414-0 330K ohm ±10% 1/4W Carbon Film
R324	RN1033414-0 330K ohm ±10% 1/4W Carbon Film
C301	EV2250251-0 2.2uF 25V +40 -20% Elect.
C302	EV2250251-0 2.2uF 25V +40 -20% Elect.
C303	EA2260351-0 22uF 35V +100, -0% Elect.
C304	DF6410301-0 0.01uF 50V ±2% Poly
C305	DF6410301-0 0.01uF 50V ±2% Poly
C308	EA1070061-0 100uF 6.3V +100, -0% Elect.
C309	EA1070061-0 100uF 6.3V +100, -0% Elect.
C310	EV1050251-0 1uF 25V +40 -20% Elect.
C311	EV1050251-0 1uF 25V +40 -20% Elect.
C312	EA1070351-0 100uF 35V Elect.
C306	DF6427201-0 0.0027uF 50V ±2% Poly
C307	DF6427201-0 0.0027uF 50V ±2% Poly
H301	HT306441C-0 2SC644(T) Transistor
H302	HT306441C-0 2SC644(T) Transistor
H303	HF200301C-0 2SK30(Y) Transistor
H304	HF200301C-0 2SK30(Y) Transistor
J301	YP1000036-0 Plug
J302	YP1000036-0 Plug
J303	YP1000036-0 Plug
J304	YP1000036-0 Plug
J305	YP1000036-0 Plug
J306	YP1000036-0 Plug
J307	YP1000036-0 Plug
P400	YD2577004-0 Tone Amp PC Board
R401	RT1039114-0 390 ohm ±10% 1/4W Carbon Film
R402	RT1039114-0 390 ohm ±10% 1/4W Carbon Film
R403	RN1047314-0 47K ohm ±10% 1/4W Carbon Film
R404	RN1047314-0 47K ohm ±10% 1/4W Carbon Film
R405	RN1056314-0 56K ohm ±10% 1/4W Carbon Film
R406	RN1056314-0 56K ohm ±10% 1/4W Carbon Film
R407	RT1068214-0 6.8K ohm ±10% 1/4W Carbon Film
R408	RT1068214-0 6.8K ohm ±10% 1/4W Carbon Film
R409	RN1022314-0 22K ohm ±10% 1/4W Carbon Film

REF. MARANTZ DESIG. PART NO.	DESCRIPTION	REF. MARANTZ DESIG. PART NO.	DESCRIPTION
R410	RN1022314-0 22K ohm ±10% 1/4W Carbon Film	J407	YP1000036-0 Plug
R411	RT1027214-0 2.7K ohm ±10% 1/4W Carbon Film	J408	YP1000036-0 Plug
R412	RT1027214-0 2.7K ohm ±10% 1/4W Carbon Film	J409	YP1000036-0 Plug
R413	RT1010214-0 1K ohm ±10% 1/4W Carbon Film	J410	YP1000036-0 Plug
R414	RT1010214-0 1K ohm ±10% 1/4W Carbon Film	J411	YP1000036-0 Plug
R415	RN1015314-0 15K ohm ±10% 1/4W Carbon Film	J412	YP1000036-0 Plug
R416	RN1015314-0 15K ohm ±10% 1/4W Carbon Film	J413	YP1000036-0 Plug
R417	RN1010114-0 100 ohm ±10% 1/4W Carbon Film	J414	YP1000036-0 Plug
R418	RN1056314-0 56K ohm ±10% 1/4W Carbon Film	J415	YP1000036-0 Plug
R419	RN1056314-0 56K ohm ±10% 1/4W Carbon Film	J416	YP1000036-0 Plug
R420	GT0522312-0 22K ohm ±5% 1/2W Carbon Film	J417	YP1000036-0 Plug
R421	GT0522312-0 22K ohm ±5% 1/2W Carbon Film	J418	YP1000036-0 Plug
R422	RN1022514-0 2.2M ohm ±10% 1/4W Carbon Film	J419	YP1000036-0 Plug
R423	RN1022514-0 2.2M ohm ±10% 1/4W Carbon Film	J420	YP1000036-0 Plug
R424	RN1068314-0 68K ohm ±10% 1/4W Carbon Film	W401	YW2579003-0 Wire Materials
R425	RN1068314-0 68K ohm ±10% 1/4W Carbon Film	P940	YD2578010-0 Tone-Control P.C. Board
R426	RT1010314-0 10K ohm ±10% 1/4W Carbon Film	R941	RD0104001-0 100K ohm B Treble Semi Fix
R427	RT1010314-0 10K ohm ±10% 1/4W Carbon Film	R942	RD0104001-0 100K ohm B Treble Semi Fix
R428	RT1010314-0 10K ohm ±10% 1/4W Carbon Film	R943	GT0516312-0 16K ohm ±5% 1/2W Carbon Film
R429	RT1010314-0 10K ohm ±10% 1/4W Carbon Film	R944	GT0516312-0 16K ohm ±5% 1/2W Carbon Film
R430	RT1022114-0 220 ohm ±10% 1/4W Carbon Film	R945	GT0516312-0 16K ohm ±5% 1/2W Carbon Film
R431	RT1022114-0 220 ohm ±10% 1/4W Carbon Film	R946	GT0516312-0 16K ohm ±5% 1/2W Carbon Film
R432	RN1010414-0 100K ohm ±10% 1/4W Carbon Film	C941	DF1622301-0 0.022uF ±10% Mylar
R433	RN1010414-0 100K ohm ±10% 1/4W Carbon Film	C942	DF1622301-0 0.022uF ±10% Mylar
C401	EV2240251-0 0.22uF 25V ±20% Elect.	C943	DF1622301-0 0.022uF ±10% Mylar
C402	EV2240251-0 0.22uF 25V ±20% Elect.	C944	DF1622301-0 0.022uF ±10% Mylar
C403	EA1060162-0 10uF 16V +100, -0% Elect.	J941	57219520W-0 Lug Eyelet
C404	EA1060162-0 10uF 16V +100, -0% Elect.	J942	57219520W-0 Lug Eyelet
C405	EA1060351-0 10uF 35V Elect.	J943	57219520W-0 Lug Eyelet
C406	EA1060351-0 10uF 35V Elect.	J944	57219520W-0 Lug Eyelet
C407	EV2250251-0 2.2uF 25V +40, -20% Elect.	J945	57219520W-0 Lug Eyelet
C408	EV2250251-0 2.2uF 25V +40, -20% Elect.	J946	57219520W-0 Lug Eyelet
C409	EA1070351-0 100uF 35V Elect.	J947	57219520W-0 Lug Eyelet
C410	EV2250251-0 2.2uF 25V +40, -20% Elect.	J948	57219520W-0 Lug Eyelet
C411	EV2250251-0 2.2uF 25V +40, -20% Elect.	P600	YD2580001-0 Main and Supply P.C. Board
C412	DF6545101-0 450PF ±5% Poly	R601	RN1068314-0 68K ohm ±10% 1/4W Carbon Film
C413	DF6545101-0 450PF ±5% Poly	R602	RN1068314-0 68K ohm ±10% 1/4W Carbon Film
C414	EV1050251-0 1uF 25V +40, -20% Elect.	R603	RN1068314-0 68K ohm ±10% 1/4W Carbon Film
C415	EV1050251-0 1uF 25V +40, -20% Elect.	R604	RN1068314-0 68K ohm ±10% 1/4W Carbon Film
H401	HT304580Z-0 2SC458(LG) (D) Transistor	R605	RT1027214-0 2.7K ohm ±10% 1/4W Carbon Film
H402	HT304580Z-0 2SC458(LG) (D) Transistor	R606	RT1027214-0 2.7K ohm ±10% 1/4W Carbon Film
H403	HT104941C-0 2SA494 (Y) Transistor	R607	RN1056314-0 56K ohm ±10% 1/4W Carbon Film
H404	HT104941C-0 2SA494 (Y) Transistor	R608	RN1056314-0 56K ohm ±10% 1/4W Carbon Film
H405	HT306441C-0 2SC644 (T) Transistor	R609	GT0510112-0 100 ohm ±5% 1/2W Carbon Film
H406	HT306441C-0 2SC644 (T) Transistor	R610	GT0510112-0 100 ohm ±5% 1/2W Carbon Film
H407	HT104941C-0 2SA494 (Y) Transistor	R611	RT1068214-0 6.8K ohm ±10% 1/4W Carbon Film
H408	HT104941C-0 2SA494 (Y) Transistor	R612	RT1068214-0 6.8K ohm ±10% 1/4W Carbon Film
J401	YP1000036-0 Plug	R613	RT1047214-0 4.7K ohm ±10% 1/4W Carbon Film
J402	YP1000036-0 Plug	R614	RT1010314-0 10K ohm ±10% 1/4W Carbon Film
J403	YP1000036-0 Plug	R615	RT1010314-0 10K ohm ±10% 1/4W Carbon Film
J404	YP1000036-0 Plug	R616	RN1018414-0 180K ohm ±10% 1/4W Carbon Film
J405	YP1000036-0 Plug	R617	RN1018414-0 180K ohm ±10% 1/4W Carbon Film
J406	YP1000036-0 Plug		

REF. MARANTZ DESIG. PART NO.	DESCRIPTION
R620	GT0522112-0 220 ohm ±5% 1/2W Carbon Film
R621	GT0522112-0 220 ohm ±5% 1/2W Carbon Film
R622	RC1012212-0 1.2K ohm ±10% 1/2W Solid
R623	RC1012212-0 1.2K ohm ±10% 1/2W Solid
R624	RC1033212-0 3.3K ohm ±10% 1/2W Solid
R625	RC1033212-0 3.3K ohm ±10% 1/2W Solid
R626	RC1082112-0 820 ohm ±10% 1/2W Solid
R627	RC1082112-0 820 ohm ±10% 1/2W Solid
R628	RT1033114-0 330 ohm ±10% 1/4W Carbon Film
R629	RT1033114-0 330 ohm ±10% 1/4W Carbon Film
R630	RC1010112-0 100 ohm ±10% 1/2W Carbon Film
R631	RC1010112-0 100 ohm ±10% 1/2W Carbon Film
R632	RC1010112-0 100 ohm ±10% 1/2W Carbon Film
R633	RC1010112-0 100 ohm ±10% 1/2W Carbon Film
R634	RC1010212-0 1K ohm ±10% 1/2W Solid
R635	RC1050012-0 50 ohm ±10% 1/2W Solid
R636	RT1047214-0 4.7K ohm ±10% 1/4W Carbon Film
R637	RT1047214-0 4.7K ohm ±10% 1/4W Carbon Film
R639	RT1033214-0 3.3K ohm ±10% 1/4W Carbon Film
R640	RT1033214-0 3.3K ohm ±10% 1/4W Carbon Film
C601	EV2240251-0 0.22uF 25V ±20% Elect.
C602	EV2240251-0 0.22uF 25V ±20% Elect.
C603	EA2270252-0 220uF 25V Elect.
C604	ED1060102-0 10uF 10V Elect.
C605	ED1060102-0 10uF 10V Elect.
C606	EV1050251-0 1uF 25V Elect.
C607	EV1050251-0 1uF 25V Elect.
C608	DF3656001-0 56PF ±10% Mica
C609	DF3656001-0 56PF ±10% Mica
C610	EA3360252-0 33uF 25V Elect.
C611	EA3360252-0 33uF 25V Elect.
C612	DD1620101-0 200PF ±10% Ceramic
C613	DD1620101-0 200PF ±10% Ceramic
C614	EA2260351-0 22uF 35V Elect.
C615	EA2260351-0 22uF 35V Elect.
C616	DK1840301-0 .04uF +100, -0% Ceramic
C617	EA4770351-0 470uF 35V Elect.
C618	EA4770351-0 470uF 35V Elect.
C619	EC4770501-0 470uF 50V Elect.
C620	EA4770252-0 470uF 25V Elect.
C621	EA1070252-0 100uF 25V Elect.
C622	EA1070252-0 100uF 25V Elect.
C623	DK1810351-0 0.01uF 500V +100, -0% Ceramic
C624	DK1810351-0 0.01uF 500V +100, -0% Ceramic
H601	HT306441B-0 2SC644 (S) Transistor
H602	HT306441B-0 2SC644 (S) Transistor
H603	HT304580B-0 2SC458 LG(B) Transistor
H604	HT304580B-0 2SC458 LG(B) Transistor
H605	HT105611C-0 2SA561 Y Transistor
H606	HT105611C-0 2SA561 Y Transistor
H607	HT307341C-0 2SC734 Y Transistor
H608	HT307341C-0 2SC734 Y Transistor
H609	HV0000105-0 M8513 R Varistor
H610	HV0000105-0 M8513 R Varistor
H611	HD3000201-0 Zenner AW-01-30 Diode

REF. MARANTZ DESIG. PART NO.	DESCRIPTION
H612	HD2000301-0 AC Rect. HP-5A Diode
H613	HD2000301-0 AC Rect. HP-5A Diode
H614	HD2000301-0 AC Rect. HP-5A Diode
H615	HD2000301-0 AC Rect. HP-5A Diode
H616	HD2000301-0 AC Rect. HP-5A Diode
*H617	HT309714A-0 2SC971 Transistor
J601	YP1000036-0 Plug
J602	YP1000036-0 Plug
J603	YP1000036-0 Plug
J604	YP1000036-0 Plug
J605	YP1000036-0 Plug
J606	YP1000036-0 Plug
J607	YP1000036-0 Plug
J608	YP1000036-0 Plug
J609	YP1000036-0 Plug
J610	YP1000036-0 Plug
J611	YP1000036-0 Plug
J612	YP1000036-0 Plug
J613	YP1000036-0 Plug
J614	YP1000036-0 Plug
R001	RC1068012-0 68 ohm ±10% 1/2W Solid
R002	RC1068012-0 68 ohm ±10% 1/2W Solid
R003	RC1008212-0 8.2 ohm ±10% 1/2W Solid
R004	RK0104003-0 100K ohm (B) Variable
R005	RM0254008-0 250K ohm (MN) Variable
R006	RM0254009-0 250K ohm (A) Variable
R007	RC1039112-0 390 ohm ±10% 1/2W Solid
R008	RC1039112-0 390 ohm ±10% 1/2W Solid
R009	GS1015105-0 150 ohm ±10% 5W Wire Wound
R010	GS1010103-0 100 ohm ±10% 3W Wire Wound
R011	RC1056112-0 560 ohm ±10% 1/2W Solid
R015	RC1039112-0 390 ohm ±10% 1/2W Solid
R016	RC1027112-0 270 ohm ±10% 1/2W Solid
R017	RT1022501-0 2.2M ohm ±10% 1W Carbon Film
R020	GS1015105-0 150 ohm ±10% 5W Wire Wound
R021	RT1056314-0 56K ohm ±10% 1/4W Carbon Film
C016	DK1810402-0 0.1uF +100, -0% Ceramic
C001	DC1810201-0 0.001uF +100, -0% Feed thru
C002	DC1103002-2 3PF ±0.5PF Feed thru
C003	DD1105001-0 5PF ±0.5PF Ceramic
C004	DK1710301-0 0.01uF ±20% Ceramic
C005	ED3360061-0 33uF 6.3V Elect.
C006	DF5547201-0 0.0047uF ±5% Poly
C007	EA1070351-0 100uF 35V Elect.
C008	EC1080501-0 1000uF 50V Elect.
C009	ED4770351-0 470uF 35V Elect.
C010	CA0330001-0 AM 3 Gang Variable
C011	DO0747353-0 0.047uF (600V DC) Oil Paper
R022	RT1010414-0 100K ohm ±10% 1/4W Carbon Film
H001	HD3000101-0 AW-01-12 (12V) Diode
H002	HD3001009-0 IS336 (11V) Diode
S001	SR0606006-0 For Function Rotary Switch
*S002	SP0401007-0 For Ant. Tuning Push Switch

REF. DESIG.	MARANTZ PART NO.	DESCRIPTION	REF. DESIG.	MARANTZ PART NO.	DESCRIPTION
*S003	SP0402001-2	Push Switch	R903	GT0547212-0	4.7K ohm ±5% 1/2W Carbon Film
*S004	SP0401006-2	For AC Supply Push Switch	R904	GT0547212-0	4.7K ohm ±5% 1/2W Carbon Film
S005	SS0202017-0	Slide Switch	R905	GT0556312-0	56K ohm ±5% 1/2W Carbon Film
J001	YT0304003-0	4P for AM-FM Ant Terminal	R906	GT0556312-0	56K ohm ±5% 1/2W Carbon Film
J002	YT0202007-0	For Output 2P Terminal	R907	RN1010514-0	1M ohm ±10% 1/4W Carbon Film
J003	YJ0400032-0	For AC Supply Socket	R908	RN1010514-0	1M ohm ±10% 1/4W Carbon Film
J004	YT0210001-0	10P Terminal	R909	RN1022514-0	2.2M ohm ±10% 1/4W Carbon Film
J005	YJ0100055-0	For Headphone Jack	R910	RN1022514-0	2.2M ohm ±10% 1/4W Carbon Film
J006	YJ0100055-0	For Headphone Jack	R911	RT1010314-0	10K ohm ±10% 1/4W Carbon Film
J007	YJ0100055-0	For Headphone Jack	R912	RT1010314-0	10K ohm ±10% 1/4W Carbon Film
J008	YJ0400032-0	For AC Supply Socket	R913	RT1015414-0	150K ohm ±10% 1/4W Carbon Film
J009	YJ0400032-0	For AC Supply Socket	R914	RT1015414-0	150K ohm ±10% 1/4W Carbon Film
J010	YJ0200007-0	Socket	C902	DF1668301-0	0.068uF ±10% Mylar
J011	YJ0200007-0	Socket	C903	DF1668301-0	0.068uF ±10% Mylar
J012	YJ0200007-0	Socket	C904	DF1668301-0	0.068uF ±10% Mylar
J013	YJ0200007-0	Socket	C905	DF1668301-0	0.068uF ±10% Mylar
J014	YJ0200047-0	Dial Illumination Socket	C906	DF1633201-0	3300PF ±10% Mylar
J015	YJ0200048-0	Dial Illumination Socket	C907	DF1633201-0	3300PF ±10% Mylar
J016	YJ0200049-0	Dial Illumination Socket	C908	DF1633201-0	3300PF ±10% Mylar
J017	YJ0200050-0	Dial Illumination Socket	C909	DF1633201-0	3300PF ±10% Mylar
J018	YT0101003-0	For Ground Terminal	C910	DF3610101-0	100PF ±10% Mica
J020	YL0103003-0	3P Terminal	C911	DF3610101-0	100PF ±10% Mica
J021	YL0103002-0	3P Terminal	C912	DF1733301-0	0.033uF ±20% Mylar
J022	YL0105001-0	5P (UL) Terminal	C913	DF1733301-0	0.033uF ±20% Mylar
J023	YL0107001-0	7P Terminal	*S901	SP0404001-2	Push Switch
J024	YL0107001-0	7P Terminal	J901	YP1000036-0	Plug
J025	YL0107001-0	7P Terminal	J902	YP1000036-0	Plug
J026	YL0105004-0	5P Terminal	J903	YP1000036-0	Plug
J031	YL0103001-0	3P Terminal	J904	YP1000036-0	Plug
*M001	IM1103602-0	For AM-FM Tuning DC Meter	J905	YP1000036-0	Plug
*M002	IM1103603-0	For FM Tuning DC Meter	J906	YP1000036-0	Plug
*M003	IN1012004-0	MPX Lamp	P920	YD2579002-0	For Switch PC Board
*M004	IN1008001-0	Lamp	P900	YD2579002-0	For Switch PC Board
*M005	IN1008001-0	Lamp	R921	RT1010214-0	1K ohm ±10% 1/4W Carbon Film
*M006	IN1008001-0	Lamp	R922	RT1010214-0	1K ohm ±10% 1/4W Carbon Film
*M007	IN1006003-0	Lamp	R923	RT1010214-0	1K ohm ±10% 1/4W Carbon Film
*M008	IN1006003-0	Lamp	R924	RT1010214-0	1K ohm ±10% 1/4W Carbon Film
*M009	IN1006003-0	Lamp	*S921	SP0402001-2	Push Switch
*M010	IN1006003-0	Lamp	J921	YP1000036-0	Plug
F001	FR1005001-0	0.5A Circuit Breaker	J922	YP1000036-0	Plug
W001	YC0240001-0	For AC Supply AC Power Cord	J923	YP1000036-0	Plug
W002	YW2579001-4	Wire Materials	J924	YP1000036-0	Plug
*L001	LF1140036-0	AM Ant Coil	J925	YP1000036-0	Plug
L002	LB3007525-0	Balun	J926	YP1000036-0	Plug
L003	LC1223001-0	Choke Coil	J927	YP1000036-0	Plug
L004	TS1660201-0	Power Transformer	J928	YP1000036-0	Plug
*L005	LY4024002-0	Relay	J929	YP1000036-0	Plug
P900	YD2579001-0	For Switch PC Board	P980	YD2578011-0	P.C. Board
R901	GT0547212-0	4.7K ohm ±5% 1/2W Carbon Film	P984	RT1047414-0	470K ohm ±10% 1/4W Carbon Film
R902	GT0547212-0	4.7K ohm ±5% 1/2W Carbon Film	R985	RT1039314-0	39K ohm ±10% 1/4W Carbon Film

REF. DESIG.	MARANTZ PART NO.	DESCRIPTION
R986	RC1033101-0	330 ohm 10% 1W Solid
C982	EA2270104-0	220uF 10V Elect.
C983	EA1050501-0	1uF 50V Elect.
H982	HT309842A-0	2SC984 (C or D) Transistor
H983	HT306962A-0	2SC696 (B or E) Transistor
J983	YP1000036-0	Plug
J984	YP1000036-0	Plug
J987	YP1000036-0	Plug
T981	257711806-0	Speacer

REF. DESIG.	MARANTZ PART NO.	DESCRIPTION
-------------	------------------	-------------



marantz

MARANTZ CO., INC. • P.O. BOX 99 • SUN VALLEY, CALIFORNIA • 91352



A WHOLLY-OWNED SUBSIDIARY OF SUPERSCOPE INC., SUN VALLEY, CALIFORNIA 91352